

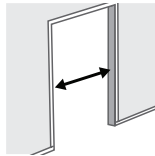

A HIGHER STANDARD OF SAFETY™

## USER GUIDE

### Crystal and Spectrum - Pressure Mount

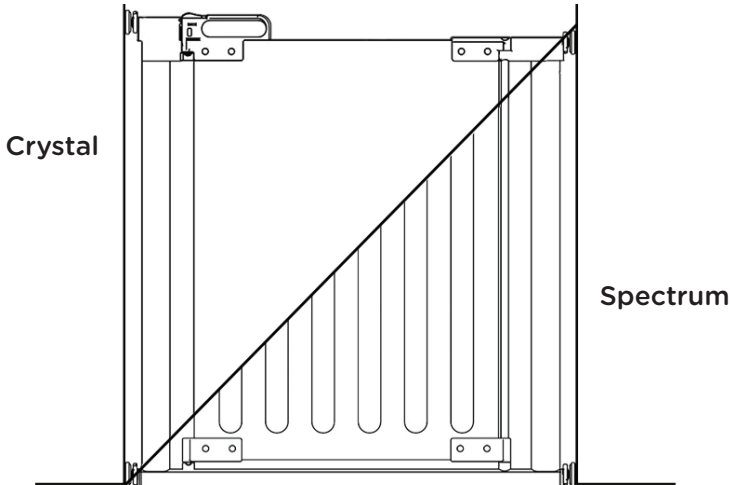

**Min  
Opening**  
29.9"  
(76 cm)

**Max Opening  
with 2 extensions  
(included)**  
37.8" (96 cm)

**Max Opening  
with 6 extensions**  
48.8" (124 cm)

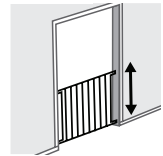

**Height**  
30.3"  
(77 cm)

**IMPORTANT:** Qdos wants to keep your children safe and for that we need you to do your part by carefully reading and following the instructions below. Please read through the instructions before starting the installation.

*For installation videos and FAQ go to: [QdosSafety.com](http://QdosSafety.com)*

## IMPORTANT!

PLEASE READ AND FOLLOW THESE INSTRUCTIONS CAREFULLY AND KEEP FOR FUTURE REFERENCE

When installed between two strong and rigid surfaces and according to these instructions, this gate has been tested to meet or exceed the following Safety Standards, US- ASTM F-1004, Canada- SOR/90-39, and European- EN 1930.

### ⚠️ WARNING

- Children have died or been seriously injured when gates are not securely installed.
- ALWAYS install and use gates as directed using all required parts.
- Intended for use with children from 6 months up to 24 months of age.
- STOP using when a child can climb over or dislodge the gate.
- NEVER use to keep child away from pool.
- Use only with the locking mechanism securely engaged.
- Regularly check all hardware and do not use if any part of gate is broken or missing.
- This product will not necessarily prevent all accidents. NEVER leave child unattended.
- NEVER step or climb over the gate, always open to pass through.
- For indoor use only.
- NEVER use this gate at top of stairs as the bottom cross bar creates a tripping hazard.
- ALWAYS use with Wall Cups.
- Fits openings 29.9-37.8" (76-96 cm)

## HELP?

To help you install your gate quickly and easily, please go to [qdossafety.com](http://qdossafety.com) for installation videos and FAQ's to help you succeed. You may also contact our customer service at [support@qdos.zendesk.com](mailto:support@qdos.zendesk.com) or by phone at 800-593-5522.

## MAINTENANCE AND CLEANING

Check the gate regularly to ensure all the hardware and mountings are tightened. Clean using a mild soap and wipe with a damp cloth.

## WARRANTY

Your Qdos product is warranted to be free from manufacturing defects in material or workmanship for a period of 1 year from date of purchase, when used under normal conditions and in compliance with these instructions. Qdos will either repair, or at its option replace, free of charge, any parts necessary to correct any defect in material or workmanship during the warranty period.

## USE LOCATIONS

This gate is only intended to be used in doorways, at the bottom of stairs or as a room divider when installed between two strong and rigid surfaces. **NEVER USE ANY PRESSURE MOUNTED GATE AT TOP OF STAIRS!** The bottom cross bar creates a TRIPPING HAZARDS!

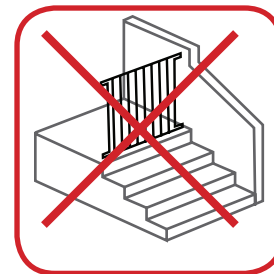

Top of stairs

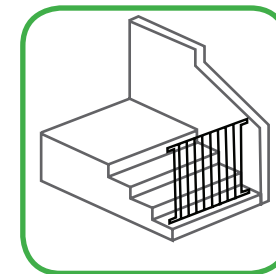

Bottom of stairs

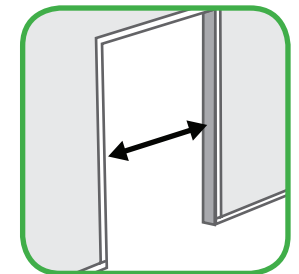

Inside Opening/  
doorway

## OPENING SIZE AND EXTENSIONS

The following table helps explain extensions needed depending on the opening size.

Inside Opening Size	Extensions Required	Included	Accessory Needed	Extension Placement
29.9-32.3" (76-82 cm)	None	Basic Gate	-	None
32.3-35" (82-89 cm)	Gate + 1 extension	Included	-	1 on one side
35-37.8" (89-96 cm)	Gate + 2 extensions	Included	-	1 on each side
37.8-40.6" (96-103 cm)	Gate + 3 extensions	-	One Extension Kit*	2 on one side and 1 on the other
40.6-43.3" (103-110 cm)	Gate + 4 extensions	-	One Extension Kit*	2 on both sides
43.3-46.1" (110-117 cm)	Gate + 5 extensions	-	Two Extension Kits*	3 on one side and 2 on the other
46.1-48.8" (117-124 cm)	Gate + 6 extensions	-	Two Extension Kits*	3 on both sides

\*Each Designer Gate Extension Kit contains two extensions, one for each side

### IMPORTANT:

Maximum 3 extensions allowed on each side for a total of 6 extensions!

## WALL CUPS AND SCREWS

We fully understand that nobody wants to create damage to or make holes in their walls. At Qdos we do our best to minimize the impact of the gate installation, but at the same time our main priority, and we sincerely hope that you share this priority, is to protect your children.

OUR GATES MUST BE USED WITH THE ADHESIVE WALL CUPS properly installed. Our Spindle heads are made out of plastic which does not provide friction against a wall or door frame to hold the gate in place.

Adhesive only installation is only recommended for the following situations:

- Painted door frames and wood framed openings

In the following situations the Adhesive Wall Cups must also be attached using the included screws:

- Painted and smooth drywall
- On wall paper
- On uneven surfaces
- On surfaces with flaking paint
- On oiled wood surfaces
- ANYTIME YOU ARE UNSURE

All gates will make some kind of mark after being used and anybody saying the opposite is simply not telling the truth. Our adhesive is removable and should only leave minor marks on the wall if removed according to the instructions. If screws have been used it's very easy to repair the screw holes with wood or drywall putty. Your children's safety is worth it! Remember that after a few years with young children it's probably time for a fresh coat of paint anyway.

## PARTS LIST:

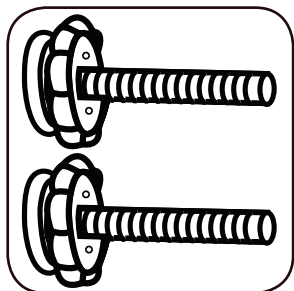

2 x Top Spindles  
with hand wheel

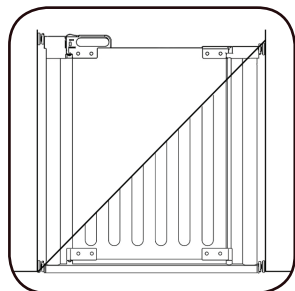

1x Crystal or Spectrum Gate,  
held together with cable tie

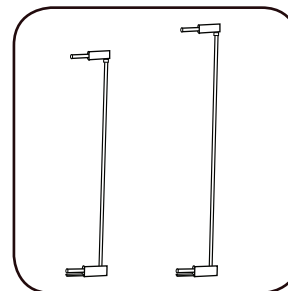

2x Gate  
Extensions  
(1 long & 1 short)

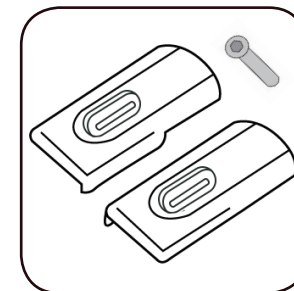

2x One-Way Stop and  
extra long Barrel Nut

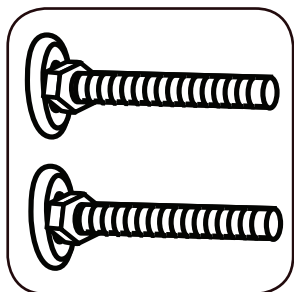

2 x Bottom Spindles  
with nuts

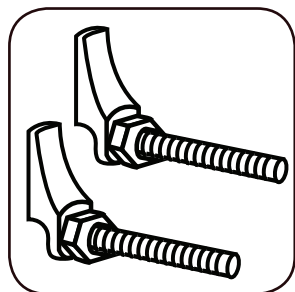

2x Quarter Round Friendly  
Spindles with nuts (for use if  
installing over quarter round)

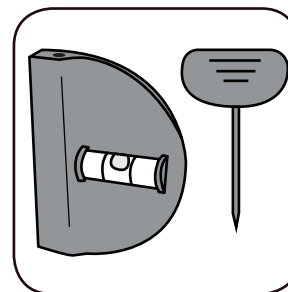

1x Magnetic Installation  
Level with Marking Tool

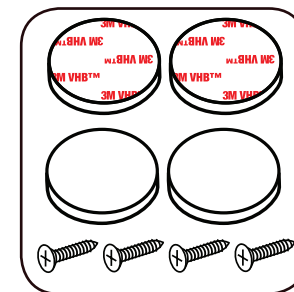

4x Adhesive Wall Cups  
with wood screws

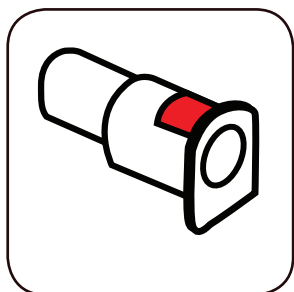

1x Bottom Spindle Housing  
with AccuInstall Indicator™

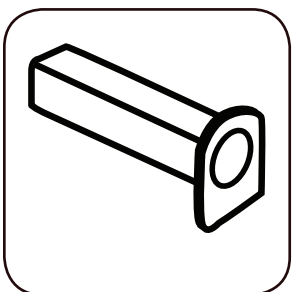

1x Bottom Spindle Housing

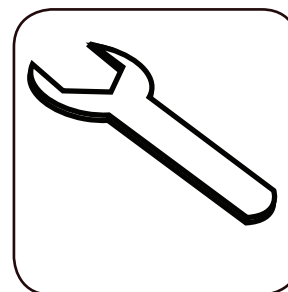

1x Installation  
Wrench

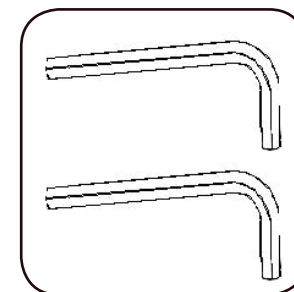

2 Allen Wrenches

## INSTALLATION

### General

This gate may only be installed at the bottom of stairs or in openings and doorways that are strong and rigid, while also having a smooth and clean mounting surface. **Do not use this gate or any pressure mount gate at the top of stairs as the bottom cross bar creates a tripping hazard!**

For challenging installation situations and surfaces, one or more of the following Qdos installation accessories might be necessary to use for a secure installation.

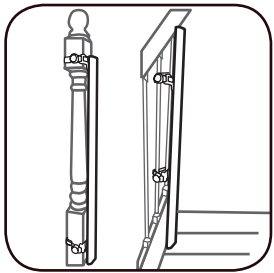

**Qdos Universal Stair Mounting Kit -**  
If installing on stair banisters or in between spindles, use Qdos Universal Stair Mounting Kit that wraps around square banister posts up to 4" and round banisters up to 5" in circumference, as well, as between stair spindles. No screws required so no damage to your staircase.

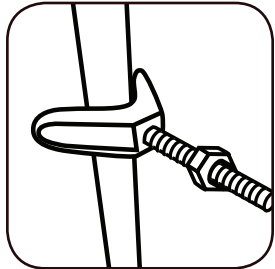

**Qdos Y-Spindles -**  
If installing directly on round stair banisters or spindles. For use on banisters up to 3" (75 mm) in diameter.

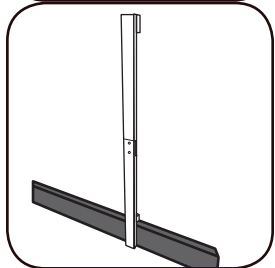

**Qdos Universal Baseboard Kit -**  
If installing where a baseboard is present. Fits over baseboards 7/8" (22 mm) thick and 7" (18 cm) tall.

## IMPORTANT:

The gate ships with a cable tie holding it together. **Please keep this cable tie in place until after Step 10 to make installation a lot easier!**

### Step 1

Measure the opening to determine if extensions are needed, please see OPENING SIZE and EXTENSION requirements on page 4.

If no extensions are needed continue to Step 2.

If extensions are needed, please go to page 14 about how to add the extensions before installing the gate in the opening.

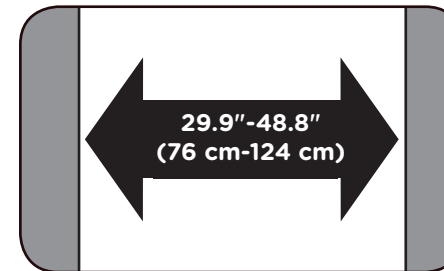

The maximum width of 48.8" (124 cm) uses the maximum allowed numbers of extensions - 6.

### Step 2

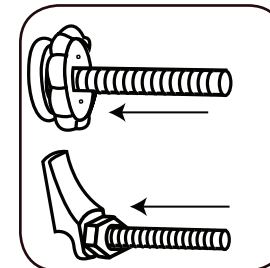

Before inserting the different spindles, make sure the handwheel or nut is screwed all the way out towards the spindle head.

### Step 3

Insert the Bottom Spindle Housing with the AccuInstall Indicator™ into the bottom bar on the locking side of the gate. Repeat the same for the Bottom Spindle Housing without the pressure indicator on the hinge side of the gate.

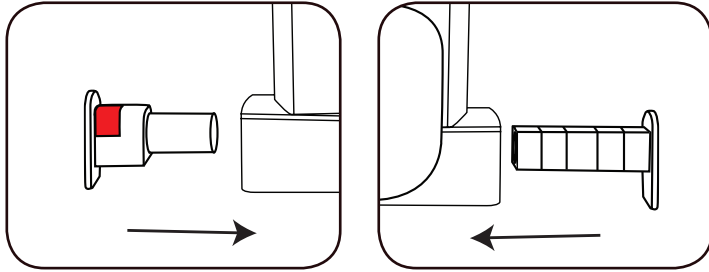

### Step 4

Slide the Bottom Spindles with nuts (or Quarter Round Friendly Spindles with nuts if you have quarter round molding present) into the Bottom Spindle Housings. Slide the Top Spindles with hand wheels into the upper hole of the Top Spindle Housings.

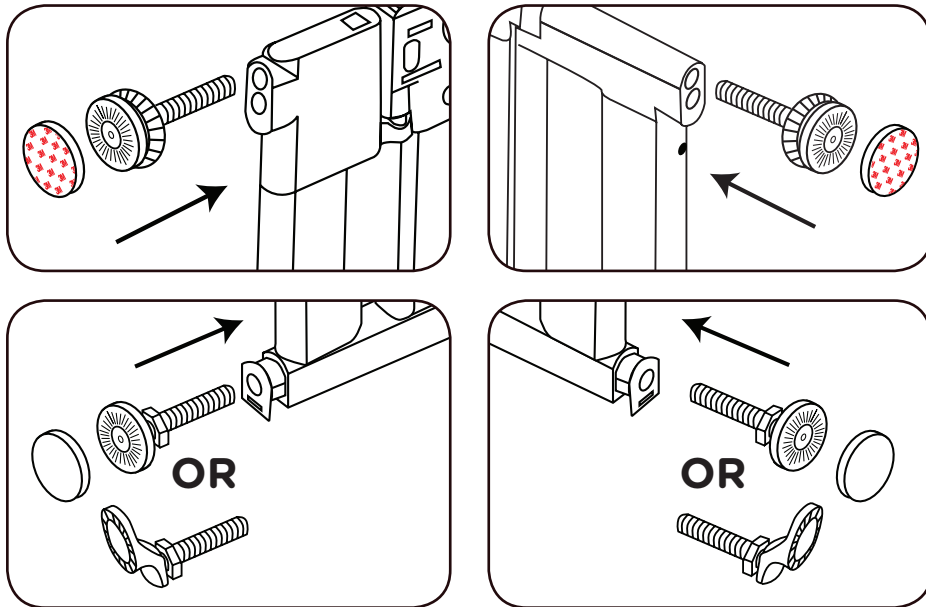

Note: If using Extensions, insert extensions into the gate (with Spindle Housings inserted in the gate) as needed for proper fit, and put the Spindles into the last extensions. See page 15.

### Step 5

**HINT** - It is easier to complete the following steps if you have a helper, one holding the gate in place while the other installs the gate.

Center gate in the opening with the Bottom Bar with Glow Strip against the floor and make sure gaps on both sides are even and not too wide. Use the Installation Level to measure the gap between the gate frame, or extension, to the door frame or wall. If the Level fits horizontally, the gap is too wide and another extension needs to be added.

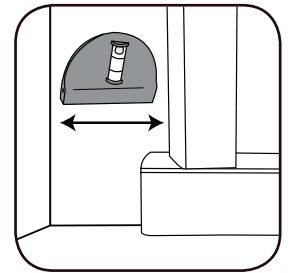

Attach Magnetic Installation Level to the hinge side of the gate to keep it vertical during the installation. This is critical as otherwise the door might not operate properly.

### Step 6

Attach the Wall Cups to the spindle heads simply by pushing them on. Use the 3M Adhesive Walls Cups for the TOP spindles and use the White Adhesive Wall Cups for the BOTTOM spindles. Remove the protective liner from the Wall Cup adhesive.

## Step 7

### IMPORTANT:

During this step it's critical to keep the gate vertical with the help of the Installation Level in order to insure that the door will operate properly.

Extend the spindles until each Wall Cup sticks to the surface (if you are using Quarter Round Friendly Spindles over a quarter round, make sure the Quarter Round Friendly Spindle head is pointing upward inside the Wall Cup). Push spindles back into gate (leaving Wall Cups sticking to wall) and temporarily remove the gate.

We strongly recommend attaching Wall Cups with the included Wall Cup screws. If screwing into drywall, carefully screw them all the way in without over-tightening. The adhesive holds the Wall Cup to the wall and the function of the screw is to prevent sideways movement. Surfaces that are not acceptable for adhesive only are - painted drywall, wallpaper, uneven surfaces, surfaces with flaking paint, or oily surfaces. If you are uncertain, it's always better to be safe rather than sorry, so we strongly recommend that you use the Wall Cup screws.

## Step 8

Reposition the gate centered in the opening and then by hand start tightening lightly the hand

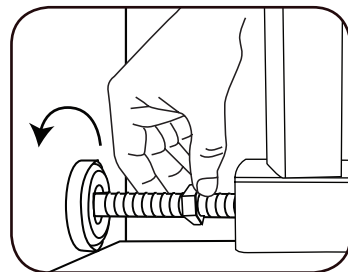
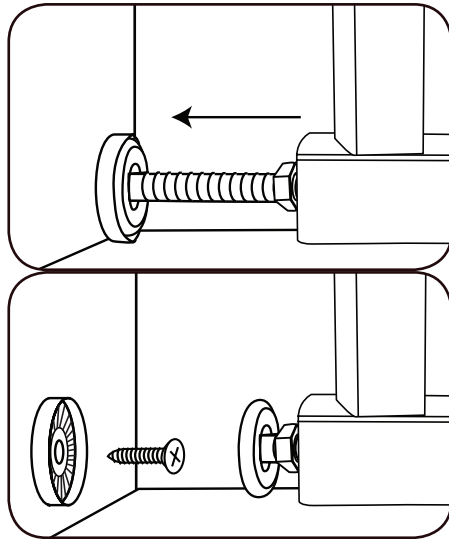

wheels on the Top Spindles and nuts on the Bottom Spindles until the spindle heads nest inside the Wall Cups. Next using the Installation Wrench, tighten the nuts on the bottom spindles. Alternate between the sides until the red area inside the AcculInstall Indicator™ disappears. This means the bottom of the gate is securely installed.

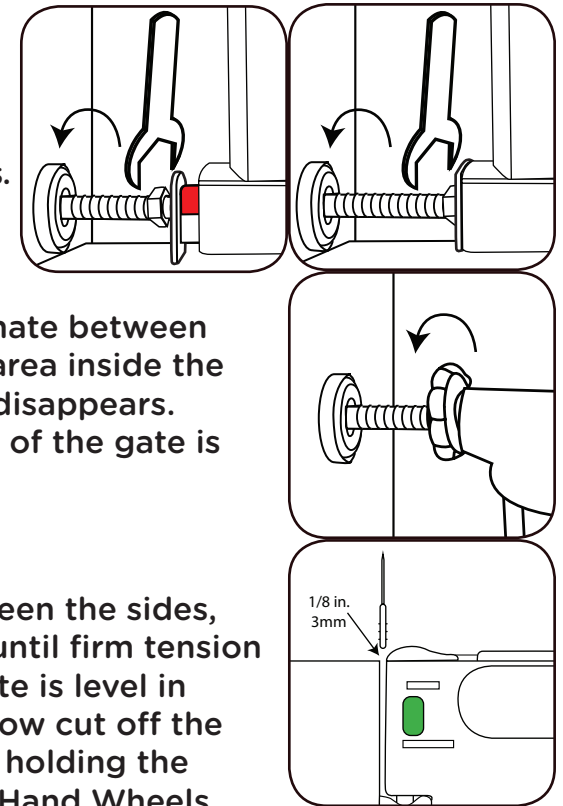

## Step 9

While alternating between the sides, turn the Hand Wheels until firm tension is achieved, and the gate is level in the opening. You can now cut off the cable tie that has been holding the gate together. Use the Hand Wheels to adjust the tension so the distance between the handle and the gate is 1/8" (3 mm). Use the Marking Tool handle attached to the Level to measure the gap.

## Step 10

To open the door, slide back on the Locking Latch and at the same time lift gate to swing open. The handle on the

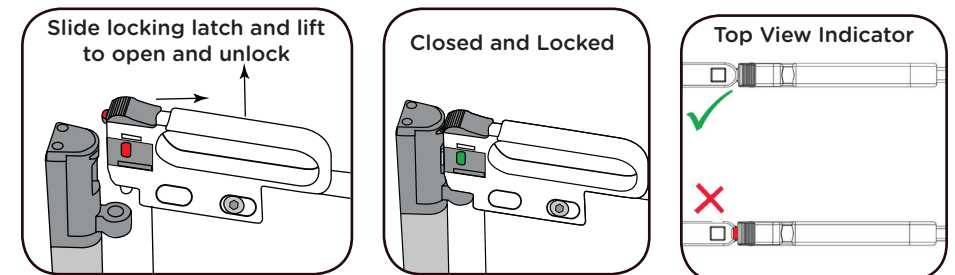

door has the At-A-Glance Lock Indicator™ to indicate if the door is locked or not. Green means that the door is locked. Red indicates the door is not locked and needs to be secured.

## Step 11

Push the door closed and check that the At-A-Glance Lock Indicator™ turns green. If the One-Way Stop is not being used, check to make sure the door closes when pushed closed in both directions. If the gate does not close and lock with the Indicator turning green, fine tune the gap between the handle and the gate.

## ONE WAY STOP

The One-Way Stop can also be used in any location where you want to restrict the opening direction. The one-way stop is attached on the lower side of the handle. There is one right-hand stop and one left-hand stop.

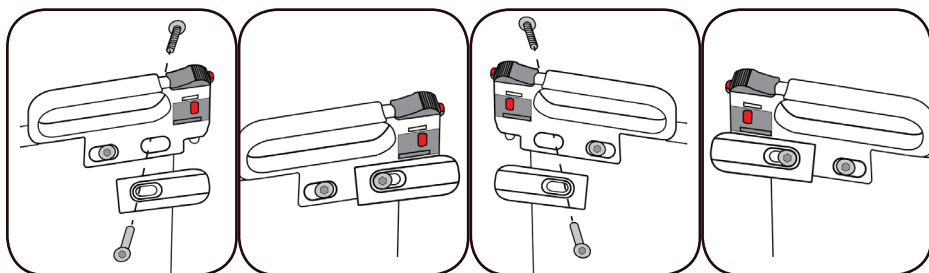

Attach the One-Way Stop on the side you have chosen to have the gate open with the “lip” lining up with the bottom of the handle. Use the Extra Long Barrel Nut and socket screw to attach.

## INSTALLATION OF EXTENSIONS

There are two extensions included with your gate, a long one and a short one. The long one will go on the locking

side and the short goes on the hinge side. When Extensions are used, insert Bottom Spindle Housings into the gate itself, Step 3. Insert Extension/s into the Spindle Housings and push all the way in both at the top and bottom.

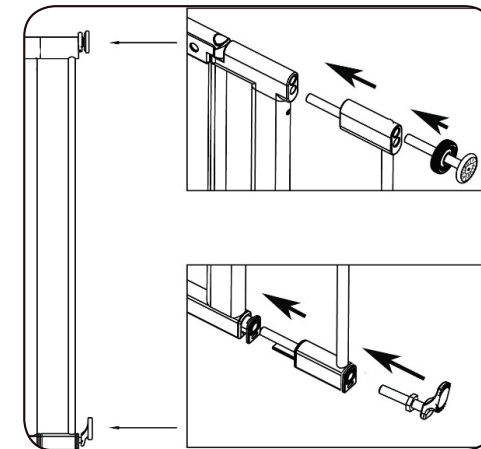

Each Extension comes with Spindle Housings already inserted, so the Spindles can be inserted directly into the last Extension on each side. When adding multiple extensions, make sure to add them on every other side of the gate, unless there is only one Extension used. Example - If using 1, put it on the hinge side; if using 3, put two on the hinge side and 1 on the locking side, etc.

Now go to Step 2 for instructions how to install the complete gate.

## GATE OPERATION

To open the gate slide back the locking latch, while at the same time lift the gate and open the door. After passing through the gate, use our “push to close” feature by simply pushing door closed and the gate will automatically lock.

## REMOVAL OF ADHESIVE WALL CUPS

Remove screws, if they have been used. Use a string of dental floss to carefully “saw” through the foam until the wall cup comes off. For remaining tape residue, use a finger to simply rub it away. If screws have been used it’s very easy to repair the screw holes with wood or drywall putty.





Distributed by Regal Lager, Inc.  
Kennesaw, GA 30144 USA  
1-800-593-5522 • [www.QdosSafety.com](http://www.QdosSafety.com)  
[support@qdos.zendesk.com](mailto:support@qdos.zendesk.com)

©2019 Qdos All rights reserved.  
Qdos is a trademark of Regal Lager, Inc.  
Made in China